

ADCATHERM - STH Series Shell and Tube Heat Exchangers (Steam to water - Horizontal installation)

DESCRIPTION

The ADCA-ST series steam to water shell and tube heat exchangers are shorter and lighter than the alternative shell and tube exchangers manufactured with smooth pipes. The use of extruded low fin tubes, has the advantage that it can improve the external surface and thermal performance.

MAIN FEATURES

Corrosion-resistant stainless steel low finned tube bundle construction.

Straight tubes for easy cleaning.

Floating head at the end of the tube bundle, avoiding tube stresses caused by thermal expansion and contraction.

OPTIONS : Vertical installation, see STV catalogue.

USE : Steam, water, hot condensate and other fluids compatible with the construction.

AVAILABLE MODELS: STH/S – Carbon steel shell
STH/SS – Complete st. steel

CONNECTIONS : Flanged or screwed, according to EN 1092-1 or ANSI standards.

INSTALLATION: Floor, wall, hanging from the ceiling.
Steam runs inside the tubes and process water outside.

ORDER REQUIREMENTS: Steam pressure and temperature
Inlet and outlet water temperature
Water mass flow or heat exchanged.
See inquiry sheet.



LIMITING CONDITIONS **					
Rating	Press. bar	Temp. °C	Rating	Press. bar	Temp. °C
PN16	16	50	ANSI Cl.150 lbs	16	50
	14	100		14	100
	13 *	195		13 *	195
	12	250		-	-

*PMO-Max.operating pressure for saturated steam.

Minimum operating temp.: -10°C. Design code: AD-Merkblatt

** Rating according to EN1092:2007.

CE MARKING - GROUP 2 GASES CATEGORIES			
RATING	MODEL	CATEGORY Tube side	CATEGORY Shell side
PN16	STH4.075 to 4.150	1	SEP
	STH5.075 to 5.150	1	SEP
	STH6.075 to 6.150	1	SEP
	STH8.075 to 8.150	2	SEP
	STH10.075 to 10.150	2	SEP
	STH8.075 to 8.150	2	SEP
	STH10.075 to 10.150	2	SEP
	STH12.075 to 12.150	3	SEP

CE Marking : This product has been designed for use on water and steam which are in Group 2 of the PED-European Pressure Equipment Directive 97/23/EC and it complies with those requirements. The product carries the CE mark.

MATERIALS		
DESIGNATION	STH/S	STH/SS
Tube bundle	AISI316L / 1.4404	AISI316L / 1.4404
Tubesheet	AISI316 / 1.4401	AISI316 / 1.4401
Heads and shell	S235 JRG2 / 1.0038 ; P235GH / 1.0305	AISI316 / 1.4401; AISI316L / 1.4404
Inlet / Outlet pipes	P235GH / 1.0305	AISI316 / 1.4401
EN flanges	P250GH / 1.0460	AISI316 / 1.4401
ANSI Flanges	ASTM A105 / 1.0432	AISI316 / 1.4401
Sockets	ASTM A105 / 1.0432	AISI316 / 1.4401
Suports	S235 JRG2 / 1.0038	AISI304 / 1.4301

EN 10204 3.1 certificate available if requested with the order.

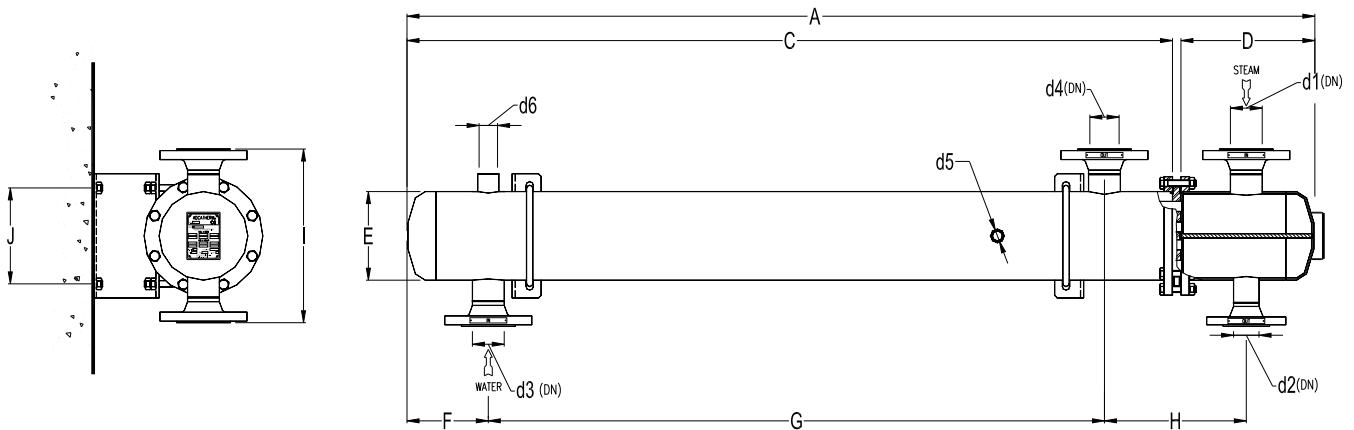

DIMENSIONS

Model	A	C	D	E	F	G	H	I	J	d1	d2	d3	d4	d5	d6
STH4.075	965	785	166	114	120	550	207	314	116	50	25	50	50	1/2"	3/4"
STH4.100	1215	1035	166	114	120	800	207	314	116	50	25	50	50	1/2"	3/4"
STH4.150	1715	1535	166	114	120	1300	207	314	116	50	25	50	50	1/2"	3/4"
STH5.075	1050	790	245	140	160	510	276	340	150	65	40	65	65	1/2"	3/4"
STH5.100	1300	1040	245	140	160	760	276	340	150	65	40	65	65	1/2"	3/4"
STH5.150	1800	1540	245	140	160	1260	276	340	150	65	40	65	65	1/2"	3/4"
STH6.075	1093	820	255	168	180	500	288	368	180	65	40	65	65	1/2"	3/4"
STH6.100	1343	1070	255	168	180	750	288	368	180	65	40	65	65	1/2"	3/4"
STH6.150	1843	1570	255	168	180	1250	288	368	180	65	40	65	65	1/2"	3/4"
STH8.075	1176	840	320	220	197	487	304	420	230	80	50	80	80	1/2"	1"
STH8.100	1426	1090	320	220	197	737	304	420	230	80	50	80	80	1/2"	1"
STH8.150	1926	1590	320	220	197	1237	304	420	230	80	50	80	80	1/2"	1"
STH10.075	1185	855	306	273	205	448	356	473	285	80	50	80	80	1/2"	1"
STH10.100	1435	1105	306	273	205	698	356	473	285	80	50	80	80	1/2"	1"
STH10.150	1935	1605	306	273	205	1198	356	473	285	80	50	80	80	1/2"	1"
STH12.075	1307	877	407	324	277	400	430	540	336	100	50	100	100	1/2"	1"
STH12.100	1557	1127	407	324	277	650	430	540	336	100	50	100	100	1/2"	1"
STH12.150	2057	1627	407	324	277	1150	430	540	336	100	50	100	100	1/2"	1"

∅ d1 to d4 connections sized according with the flow conditions.

Dimensions are subject to change without notice.

Consult factory for certified dimensions and weight.

Other sizes and designs can be supplied under request.

The pipe connections are sized considering the correct thermal insulation possibility. The insulation it's not included but it is recommended to be done after the installation.



HEAT EXCHANGER FAX INQUIRY

Please send the inquiry for your *AdcaTherm* steam to water heat exchanger with the following parameters:

	TUBE SIDE	SHELL SIDE
FLUID	SATURATED STEAM	WATER
OPERATING PRESSURE	bar	bar
INLET TEMPERATURE	° C *	° C
OUTLET TEMPERATURE	° C *	° C
FLOW RATE	Kg/h *	Kg/h or m3/h
HEAT EXCHANGED (Option)	KW or	Kcal/h
MODEL REQUIRED (Please select)	STH (Horizontal)	STV (Vertical)

Remarks :

* Not necessary in case of saturated steam.

STH – Horizontal installation ; STV – Vertical installation.

Your company name:	
Contact :	
Address :	
Country :	
Tel.:	Fax.:
E-mail:	Web-page:
